

## GV-SD2301 (20x) PoE Outdoor Full HD IP Speed Dome



- 1/2.8" progressive scan super low lux CMOS sensor
- Min. illumination at 0.001 lux
- Full HD 1080p at up to 30 fps and 720p at up to 60 fps
- 20x optical zoom and 12x digital zoom
- Wide Dynamic Range Pro (WDR Pro)
- Day and night function with IR-cut filter
- 2-way audio
- Vandal resistance (IK10 for metal and polycarbonate casing)
- Ingress protection (IP67)
- Built-in SD card slot (SD/SDHC) for local storage
- 4 digital inputs, 1 relay output
- DC 24V / AC 24V / High PoE (PoE++, 50 W)
- Pan 360° endlessly
- Tilt from -20° to 200°
- Preset speed at up to 460° /sec
- PTZ movement (Preset, Sequence, Auto Pan, Cruise and Tour)
- PTZ movements by schedule
- Auto and manual PTZ calibration
- Auto focus
- Backlight Compensation
- Image noise reduction
- Motion detection
- Privacy Mask
- Dual streams from H.264 and MJPEG
- Smart phones & 3GPP support
- 31 languages on Web interface
- ONVIF (Profile S) conformant
- \* No memory card slot & local storage function for Argentina
- \* Optional GV-PA901 PoE Adapter is required for applying PoE function

### Introduction

The GV-IP Speed Dome (GV-SD2301) is a network PTZ camera designed for image quality and adaptability in various environments. This camera offers image of 1080p at 30 fps, 720p at 60 fps and 20x optical zoom, capable of showing smooth live view with great detail. In low-light environments, image quality is promised with its image processing tools, such as IR-cut filter (ICR), Wide Dynamic Range Pro (WDR Pro), Backlight Compensation and noise reduction.

Wide surveillance coverage is made possible with 360° endless panning and -20 ~ 200° tilting capacity. Dome movements such as Preset, Sequence, Auto Pan, Cruise and Tour can be programmed and activated by schedule. You can create multiple dome movement modes and have different modes enabled at different time slots. The GV-IP Speed Dome provides variable pan/tilt speeds ranging from a fast patrol of 460° per second to a slow ramble of 0.5° per second with 0.2° pan accuracy for fast and accurate tracking ability.

GeoVision offers a complete series of GV-IP Speed Dome for indoor and outdoor use, and also optional mounting kits for outdoor installations on wall, ceiling and pole.

## Dimensions

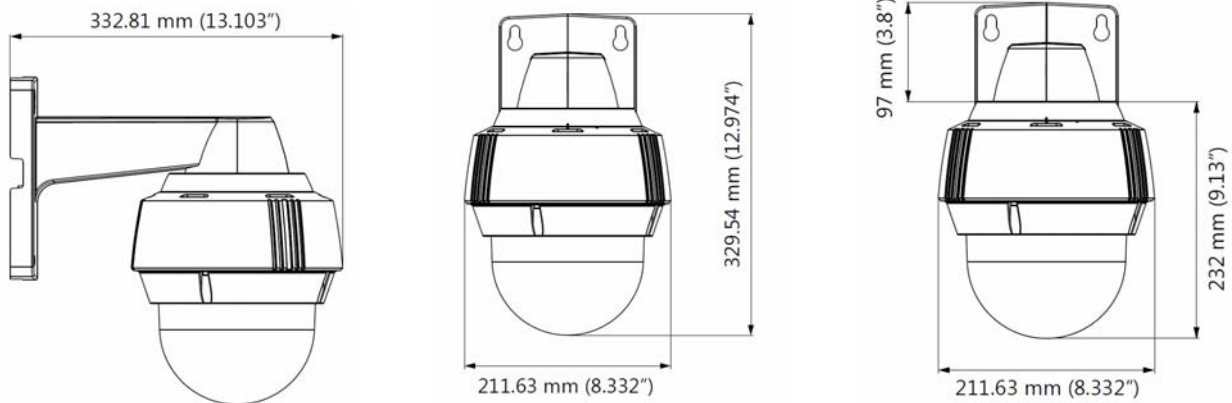

## Specifications

Camera		
Image Sensor	1/2.8" progressive scan super low lux CMOS	
Optical Zoom	20x	
Digital Zoom	12x	
Picture Elements	1920 (H) x 1080 (V)	
Minimum Illumination	Color	0.02 Lux at F/1.6
	B/W	0.001 Lux at F/1.6
Electronic Shutter	1/1 ~ 1/10000 sec.	
White Balance	Auto / Manual	
Iris Control	Auto / Manual	
AGC control	Auto / Manual	
S/N Ratio	50 dB (AGC Off)	
WDR Pro	Yes (with WDR sensor)	
Dynamic Range	Up to 100 dB	
Optical Lens		
Megapixel	Yes	
Day / Night	Yes (with removable IR-cut filter)	
Focal Length	4.7 ~ 94 mm	
Maximum Aperture	F/1.6	
Horizontal FOV	55.4° ~ 2.9°	
Operation	Focus	Auto / Manual
	Zoom	20x
	Iris	Auto / Manual
Video		
Video Compression	H.264, MJPEG	
Video Streaming	Dual streams from H.264 or MJPEG	
Video Resolution	Main Stream	16:9 1920 x 1080 (Default), 1280 x 720, 640 x 360, 448 x 252
	Sub Stream	
Frame Rate	30/25 fps at 1920 x 1080 (60/50 Hz) 60/50 fps at 1280 x 720 (60/50 Hz) * The frame rate and performance may vary depending on the number of connections and data bitrates (different scenes).	
Audio		
Audio Compression	G.711, AAC (optional)	
Audio Support	Two-way Audio	
Sensor Input	4 Input (Dry Contact)	
Alarm Output	1 Digital Output (200mA 5V DC)	

Network		
Interface	10/100M Ethernet	
Protocol	DHCP, DynDNS, FTP, HTTP, HTTPS, NTP, ONVIF (Profile S), QoS (DSCP), RTSP, SMTP, SNMP, TCP, UDP, UPnP, 3GPP/ISMA	
Mechanical		
Temperature Detector	Yes	
Connectors	Power	DC Jack, PoE ++
	Ethernet	10/100 Base-T, RJ-45 connector
	Audio	1 in (RCA female for microphone); 1 out (RCA female for speaker)
	Local Storage	SD card slot (SD/SDHC, SD version 2.0 only, Class 10) *SDXC and UHS-I card types are not supported.
	Digital I/O	I/O wires
Operation		
Pan Travel	360° endless	
Tilt Travel	-20° ~ 200°	
Manual Speed	0.5° ~ 460°/s	
Calibration	Auto / Manual	
Presets	Max. Number	255
	Accuracy	0.2°
Sequence	Max. Number	8
	Max. Presets Allowed	16
Auto Pan	8	
Cruise	4	
Tour	Max. Number	8
	Max. Number of Preset / Sequence / Auto Pan / Cruise	16
Privacy Mask	24	
Proportional Pan & Tilt	Auto (Pan and tilt speed proportional to zoom ratio)	
Automatic Function	Preset, Sequence, Auto Pan, Cruise, Tour	
Mechanical Flip	On / Off	
Digital Slow Shutter	On / Off	
Motion Detection	On / Off	
Wide Dynamic Range	On / Off	
Day/Night: Mechanical IR Cut Filter	On / Off	
Picture Flip	On / Off	
Image Freeze	On / Off	
Digital Noise Reduction	On / Off	
Alarm	Input	4
	Output	1
	Reaction	Preset, Sequence, Auto Pan, Cruise, Tour
General		
Operating Temperature	-40°C ~ 70°C (-40°F ~ 158°F)	
Heater	Heater 1 On: 5°C (41°F); Off: 8°C (46.4°F) Heater 2 On: -7°C (19.4°F); Off: -2°C (28.4°F)	
Fan-On	60°C (140°F)	
Humidity	20% ~ 90% (non-condensing)	
Dimensions	Ø 211.63 x 232 mm (8.332" x 9.13")	
Weight	3.1 kg (6.82 lb)	
Power Source	24V AC ± 10%, 3A / 24V DC ± 10%, 3.75A / High PoE++ (PoE++)	
Power Consumption	50 W (with 30 W heater)	
Ingress Protection	IP67	
Vandal Resistance	IK10 for metal and polycarbonate casing	
Regulatory	CE, FCC, RCM, RoHS compliant	
Power over Ethernet		
PoE Standard	PoE++ (50 W) / PD	
PoE Power Supply Type	End-Span	
PoE Power Output	56V DC, 1050mA. (50 W Max.)	

Web Interface	
Installation Management	Web-based configuration
Maintenance	Firmware upgrade through Web Browser or Utility
Access from Web Browser	Live View, Video Recording, PTZ Control, Preset, Sequence, Cruise, Auto Pan, Tour, Image Quality, Bandwidth Control, Image Snapshot, I/O Control, 2-way Audio, Picture-in-Picture (PIP), Picture-and-Picture (PAP), Text Overlay, Image Masking
Language	Arabic / Bulgarian / Czech / Danish / Dutch / English / Finnish / French / German / Greek / Hebrew / Hungarian / Indonesian / Italian / Japanese / Lithuanian / Norwegian / Persian / Polish / Portuguese / Romanian / Russian / Serbian / Simplified Chinese / Slovakian / Slovenian / Spanish / Swedish / Thai / Traditional Chinese / Turkish
Applications	
Network Storage	GV-System (GV-DVR / NVR), GV-VMS, GV-Backup Center, GV-Recording Server
Smart Device Access	GV-Eye for iOS and Android
Live Viewing	Browser (IE, Chrome, Firefox, Safari), Mobile Phone
CMS Server support	GV-Control Center, GV-Center V2, GV-Vital Sign Monitor

**Note:**







1. Specifications are subject to change without notice.
2. Do not use clothes or any ordinary material to clean the camera cover since they may result in scratches.
3. Mind the following when using an inserted memory card for recording:
  - Recorded data on the memory card can be damaged or lost if the data are accessed while the camera is under physical shock, power interruption, memory card detachment or when the memory card reaches the end of its lifespan. No guarantee is provided for such causes.
  - The stored data can be lost if the memory card is not accessed for a long period of time. Back up your data periodically if you seldom access the memory card.
  - Memory cards are expendable and their durability varies according to the conditions of the installed site and how they are used. Back up your data regularly and replace the memory card annually.
  - To avoid power outage, it is highly suggested to apply a battery backup (UPS).
  - For better performance, it is highly suggested to use SD card of MLC NAND flash, Class 10.
  - Replace the memory card when its read/write speed is lower than 6 MB/s or when the memory card is frequently undetected by the camera.

**Packing List**

- |                                    |                                 |
|------------------------------------|---------------------------------|
| 1. GV-SD2301 Outdoor IP Speed Dome | 6. Desiccant Pack x 2           |
| 2. Pendant Tube                    | 7. Data Cable                   |
| 3. Hex Key x 2                     | 8. GV-IP Speed Dome Software CD |
| 4. Rubber Ring                     | 9. GV-NVR Software DVD          |
| 5. RJ-45 Connector                 | 10. Warranty Card               |

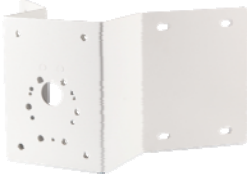
**Note:** Power adapters can be purchased upon request.

## Accessories

Model No.	Name		Details
GV-Mount102	Straight Tube Box Mount		Dimensions: 256 x 256 x 316 mm (10.1 x 10.1 x 12.4") Weight: 6.6 kg (14.6 lb)
GV-Mount103	Straight Tube Mount		Dimensions: 219 x 125 x 340 mm (8.6 x 4.9 x 13.4") Weight: 2.2 kg (4.9 lb)
GV-Mount300	Convex Corner Adapter Kit		Dimensions: 238.6 x 409.5 mm (9.4" x 16.1") Weight: 4.27 kg (9.41 lb)
GV-Mount310	Concave Corner Adapter Kit		Dimensions: 123.3.6 x 393.1 mm (4.9" x 15.5") Weight: 2.96 kg (6.53 lb)
GV-Mount400	Pole Mount Bracket Kit (Ø 4" ~ 6")		Bracket: 241 x 161 mm (9.5" x 6.3") Weight: 1.70 kg (3.75 lb) Steel Strap: Ø 4" ~ 6"
GV-Mount410	Pole Mount Bracket Kit (Ø 6" ~ 7.5")		Bracket: 241 x 161 mm (9.5" x 6.3") Weight: 1.70 kg (3.75 lb) Steel Strap: Ø 6" ~ 7.5"
GV-Mount501	Convex Corner Box Mount		Dimensions: 136 x 256 x 256 mm (5.4 x 10.1 x 10.1") Weight: 4.8 kg (10.6 lb)

Model No.	Name		Details
GV-Mount702	Extension Tube		Four options are available. Dimensions: Ø 5.4 x 10 or 20 or 30 or 50 cm (Ø 2.1" x 3.9" or 7.9" or 11.8" or 19.7") Weight: 180 g or 390 g or 550 g or 800 g (0.4 lb or 0.86 lb or 1.21 lb or 1.76 lb)
GV-Mount908-2	In-Ceiling Mounting Kit		Mounting plate: 205 x 128 x 227 mm (8.1 x 5 x 8.9") Weight:: 3 kg (6.6 lb)
GV-PA901	PoE Adapter		The GV-PA901 PoE adapter is designed to provide power and network connection to IP cameras over a single Ethernet cable.
	DC 24V Power Adapter 100-240V AC US		Dimensions (L x W): 132.75 x 58.6 mm (5.23" x 2.3") Weight: 0.39 kg (0.86 lb) Input: 100 to 240V AC 2.5A 50-60Hz Output: 24V DC 3.75 A
	DC 24V Power Adapter 100-240V AC AU		
	DC 24V Power Adapter 100-240V AC AR		
	DC 24V Power Adapter 100-240V AC EU		
	DC 24V Power Adapter 100-240V AC JU		
	DC 24V Power Adapter 100-240V AC UK		